



UV-VIS-NIR Spectrophotometer

SolidSpec-3700

SolidSpec-3700DUV





UV-VIS-NIR
Spectrophotometer

Standard model

SolidSpec-3700

Enhanced model for deep UV Measurement to 165 nm^(note)

SolidSpec-3700DUV

Shimadzu's Advanced Technology and High Reliability Lead to the Solutions for Optical, Semiconductor and FPD Fields.

High Sensitivity

The SolidSpec-3700 and 3700DUV are the FIRST UV-VIS-NIR SPECTROPHOTOMETERS with THREE DETECTORS

A photomultiplier tube (PMT) detector for the ultraviolet and visible region, and InGaAs and PbS detectors for the near-infrared region. The use of the InGaAs and PbS detectors makes the sensitivity in the near-infrared region significantly high.

Deep UV Measurement

The SolidSpec-3700DUV has the capability to measure the deep ultraviolet region down to 165 nm^(note) (or to 175 nm with an integrating sphere) by purging both the optical and the sample compartment with nitrogen gas.

Large Sample Compartment

The large sample compartment (900W × 700D × 350H mm) allows large samples to be measured without destroying the sample. The vertical optical path makes it possible to measure large samples. The whole sample area 12 inch diameter or 310 × 310 mm is measurable by mounting the automatic X-Y stage (option).

Note) 165 nm is the minimum wavelength for SolidSpec-3700DUV with its optional attachment, Direct Detection Unit DUV.

High Sensitivity

High accuracy for transmittance and reflectance is required for the measurement of optical parts. The SolidSpec-3700/3700DUV have three detectors which cover the range from ultraviolet to near-infrared. The sensitivity in the near-infrared region is significantly enhanced by using both InGaAs and cooled PbS detectors. Highly accurate and highly sensitive spectra are obtainable from ultraviolet to near-infrared. High accuracy

for transmittance and reflectance is required for the measurement of optical parts. The SolidSpec-3700/3700DUV have three detectors which cover the range from ultraviolet to near-infrared. The sensitivity in the near-infrared region is significantly enhanced by using both InGaAs and cooled PbS detectors. Highly accurate and highly sensitive spectra are obtainable from ultraviolet to near-infrared.

Three Detectors

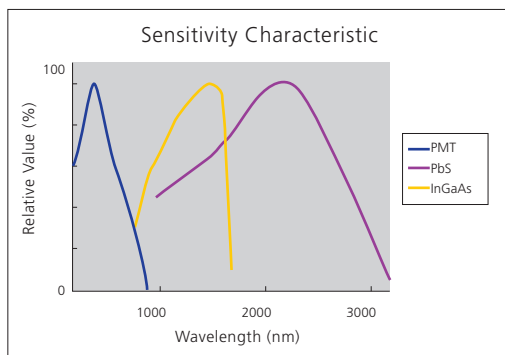
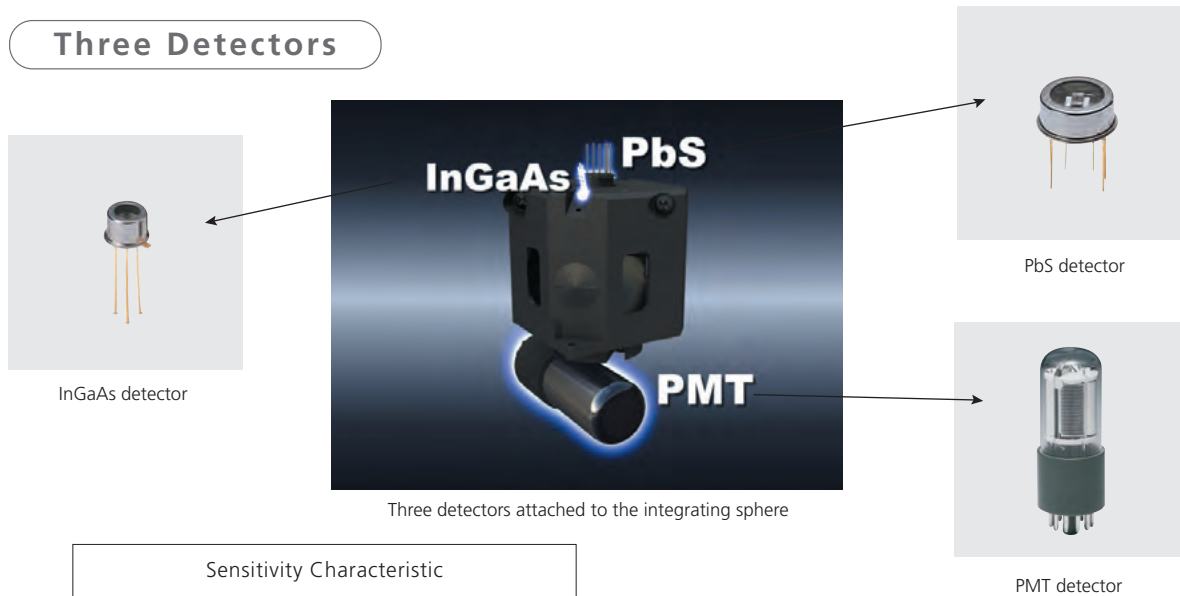

Conventional spectrophotometers have used a photomultiplier tube detector for the ultraviolet and visible region and a PbS detector for the near-infrared region. However, neither detector has much sensitivity near the detector switchover, preventing high sensitivity measurement in this range. The SolidSpec-3700/3700DUV make it possible to take high sensitivity measurements in the switchover range by using an InGaAs detector as shown in the figure on the left.

Relationship between Detectors and Measurable Range

	165 nm	380 nm	780 nm	3300 nm
	UV	Visible	NIR	
PMT	165 to 1000 nm			
InGaAs		700 to 1800 nm		
PbS			1600 to 3300 nm	

The photomultiplier tube detector can be switched to the InGaAs detector in the range from 700 nm to 1000 nm (the default switching wavelength is 870 nm). The InGaAs detector can be switched to a PbS detector in the range from 1600 nm to 1800 nm (the default switching wavelength is 1650 nm).

Measurement Comparison between Two Detectors and Three Detectors

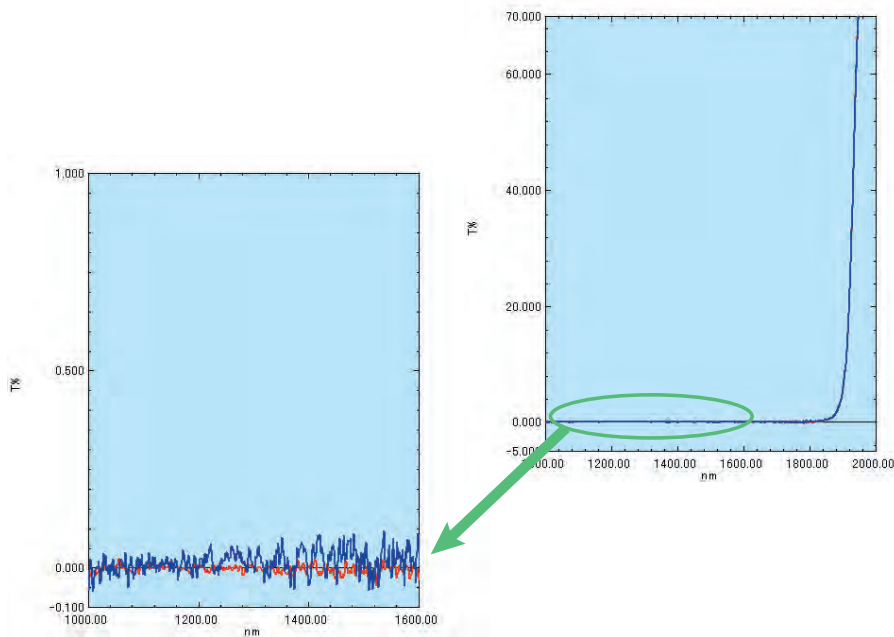

By using an InGaAs detector in combination with a photomultiplier tube (PMT) and a cooled PbS detector, the noise in the InGaAs detector range (900 nm to 1600 nm) is significantly reduced compared with that measured on the conventional two detector (PMT and PbS) spectrophotometer.

The transmittance spectra of sharp cut filter measured on an InGaAs detector and a PbS detector (conventional spectrophotometer) are shown in the figure on the left. Low noise around 0% transmittance is a very powerful tool to measure low reflection samples such as anti-reflective coatings or films used in the optical communication field.

- : SolidSpec-3700 (InGaAS detector)
- : Previous model (PbS detector)

High Accuracy Measurement with Minimized Detector Switchover Noise and Bump

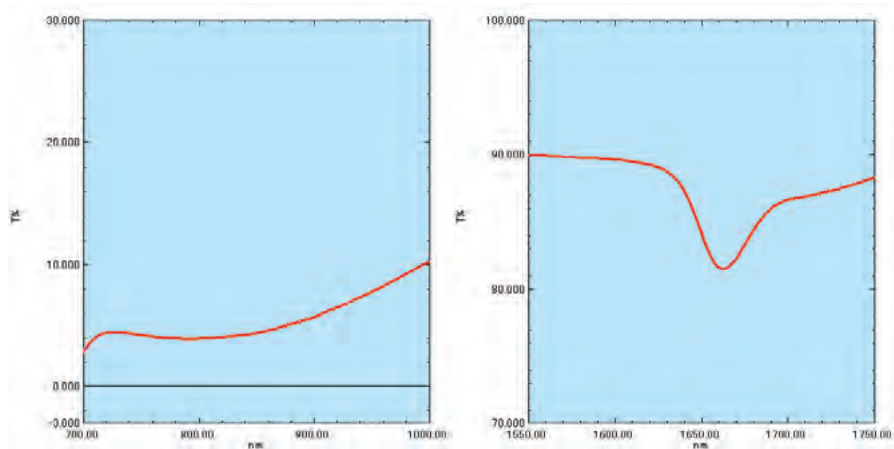

Noise and bump caused by detector switchover are minimized to assure accurate measurement.

The transmission spectra of color filter and polyester film are shown in the left and right figures, respectively. Noise or bump caused by the detector switchover range at 870 nm and 1650 nm is hardly observed.

Deep UV Measurement (SolidSpec-3700DUV)

The development of precise laser machining using an ultraviolet laser such as an ArF excimer laser enhances the requirement for transmittance or reflectance measurements of optical parts in the deep ultraviolet region. The SolidSpec-3700DUV^(note1) enables measurement in the range of 175 nm to 2600 nm^(note2) with an integrating sphere and the range of 165 nm to 3300 nm^(note3) by mounting the optional Direct Detection Unit DUV. With this additional unit, the wide range from deep ultraviolet to near-infrared is now measurable. The

development of precise laser machining using an ultraviolet laser such as an ArF excimer laser enhances the requirement for transmittance or reflectance measurements of optical parts in the deep ultraviolet region. The SolidSpec-3700DUV^(note1) enables measurement in the range of 175 nm to 2600 nm^(note2) with an integrating sphere and the range of 165 nm to 3300 nm^(note3) by mounting the optional Direct Detection Unit DUV. With this additional unit, the wide range from deep ultraviolet to near-infrared is now measurable.

Nitrogen Gas Purge

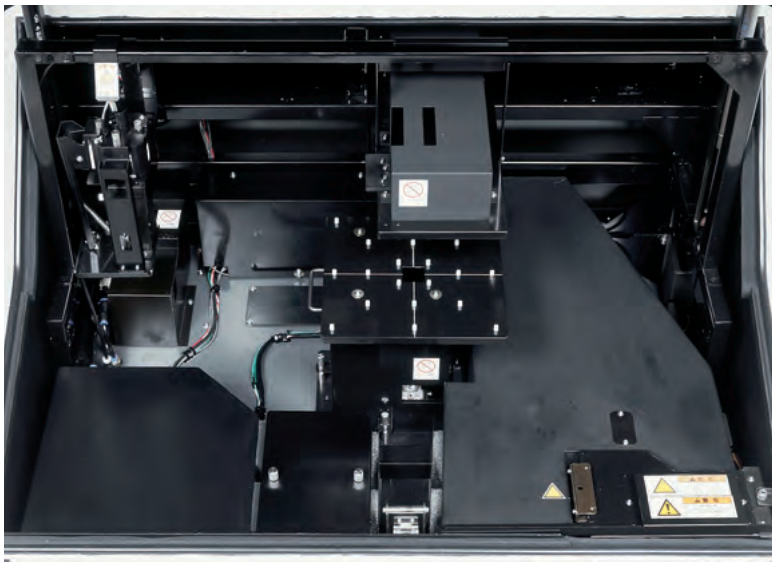

Oxygen molecules in the atmosphere absorb ultraviolet light under 190 nm. Nitrogen gas purging for both the optical and the sample compartment is required to remove the interfering oxygen molecules. Since the SolidSpec-3700DUV has purge inlets for each compartment, efficient nitrogen gas purge is possible so that the time required for purging after sample replacement is reduced, and high sensitivity with lower stray light in the deep UV region is achieved.

Integrating Sphere and Photomultiplier for the Deep Ultraviolet Region

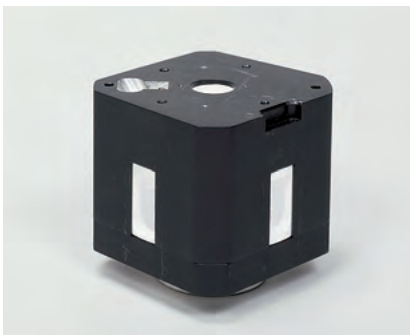

Integrating Sphere for Deep Ultraviolet



Photomultiplier for Deep Ultraviolet

Materials which do not absorb deep ultraviolet light are required to be used as the window material for the detector and the material for the inside of the integrating sphere to enable performance in the deep ultraviolet region. The SolidSpec-3700DUV uses a PMT detector with fused silica as the window material and an integrating sphere with resin that has highly reflective characteristics in the deep ultraviolet region as the inside material.

Note1) In order to measure the range below 190 nm with the SolidSpec-3700DUV, nitrogen gas purge is required to remove interference from oxygen molecules inside the SolidSpec-3700DUV.

Note2) The measurable range for SolidSpec-3700 is 240 nm to 2600 nm.

Note3) The measurable range for SolidSpec-3700 with the optional Direct Detection Unit is 190 nm to 3300 nm.

Integrating Sphere for Deep Ultraviolet Measurement

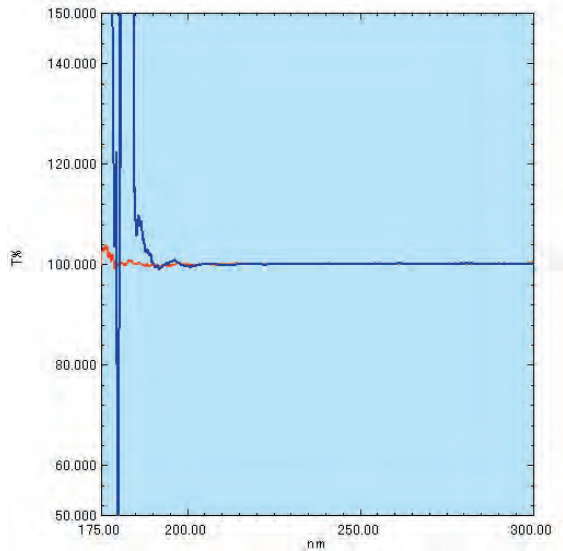

- : SolidSpec-3700DUV with an integrating sphere for the deep ultraviolet measurement
- : SolidSpec-3700 with a normal integrating sphere

Spectra with noise under 190 nm are obtainable, as compared with conventional spectrophotometers, which can be a powerful feature for the measurement of materials used for ArF laser in the semiconductor field.

The 100% baseline spectra measured on the SolidSpec-3700DUV with an integrating sphere for the deep ultraviolet measurement and the SolidSpec-3700 with a normal integrating sphere are shown in the left figure.

Application for Deep Ultraviolet Region

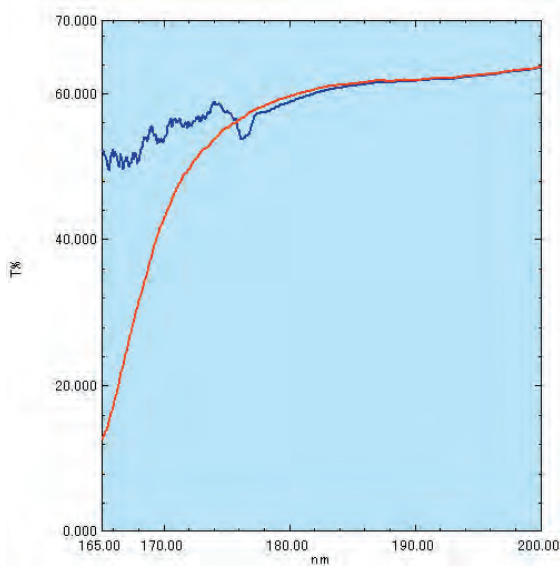

Transmission Spectra of Silica Plate

- : Transmission spectrum of Silica plate measured with nitrogen purge
- : Transmission spectrum of Silica plate measured without nitrogen purge

In order to perform high-accuracy measurements in the deep UV region, a sufficient quantity of light and significant low stray light are required. The transmission spectrum of a silica plate measured with the Direct Detection Unit DDU-DUV(option) is shown in the left figure. Spectra with significantly lower noise are obtainable in the ultraviolet region.

UVProbe

All-in-one Software

UVProbe includes four functions:

- Spectrum
- Photometric (Quantitation)
- Kinetics
- Report Generator

Each function can be easily operated with its dedicated screen. Included as standard are a wide variety of data processing functions such as peak/valley detection, area calculation, and others. Security features by which each user is limited to the use of specific functions, and an audit trail for the instrument and the data are all standard as well.

Spectrum

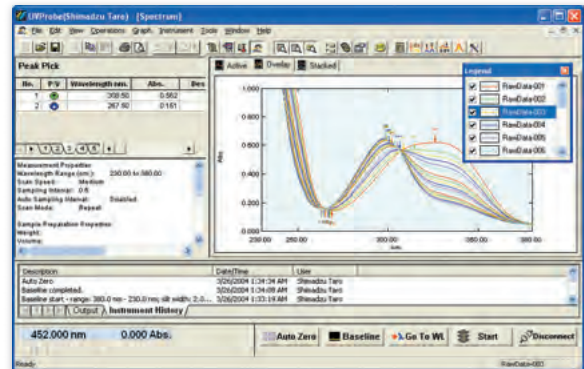

Kinetics

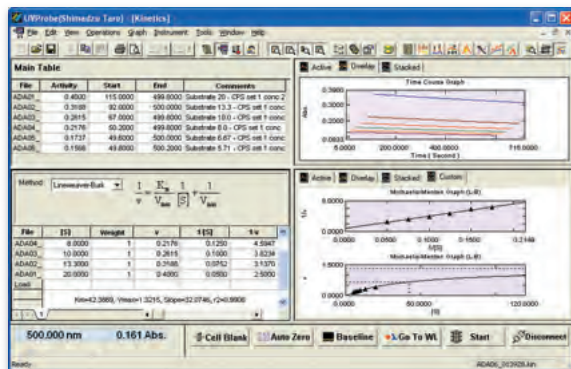

Photometric

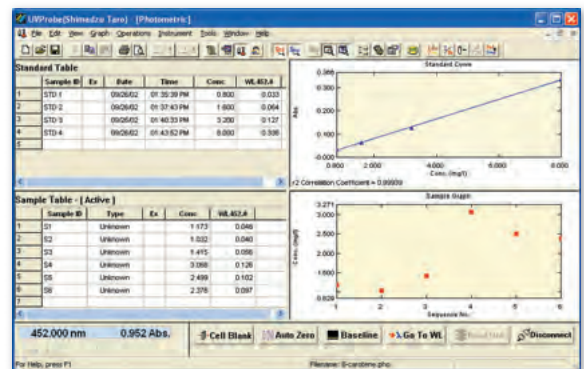

Report Generator

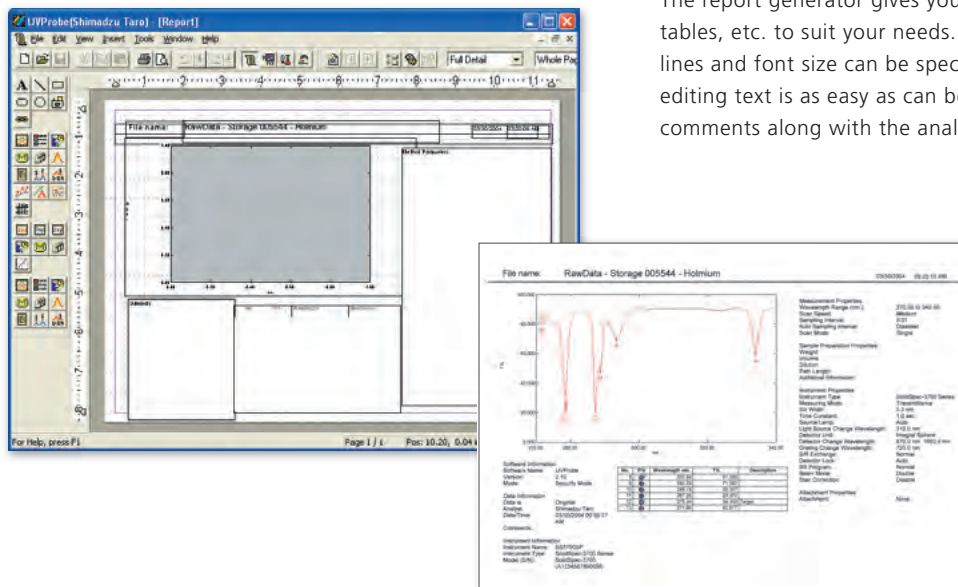

The report generator gives you the freedom to arrange graphs, tables, etc. to suit your needs. The thickness and color of graph lines and font size can be specified. Pasting labels on graphs and editing text is as easy as can be, allowing you to effectively print comments along with the analysis results.

Quick Print

Quick Print allows you to print data directly from the Spectrum, the Kinetics and the Photometric modules without moving to the Report Generator. Once the report template is stored as the

report file, the report can be printed simply by utilizing the 4th step, without steps 1 to 3.

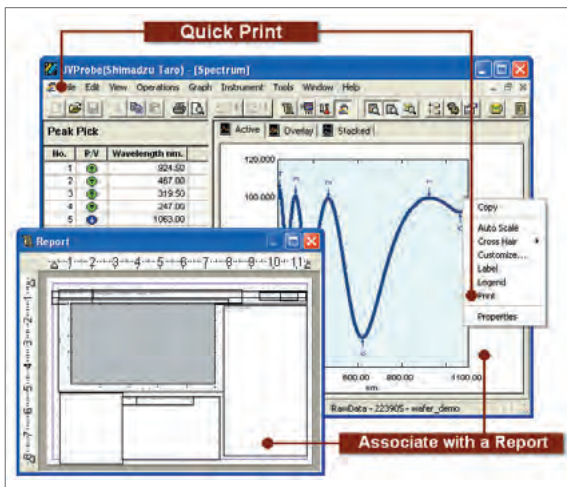

- Step 1** – Make the report template
- Step 2** – Assign the data to the report template
- Step 3** – Check the report to be printed
- Step 4** – Print the report by Quick Print

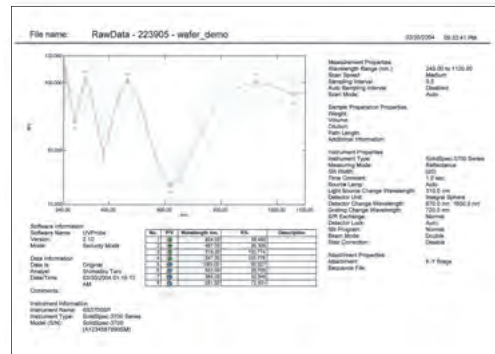

Reliability and Management of Data

As represented by ISO9001, the reliability and management of data have been increasingly required. UVProbe has security functions in which operations are limited for the individual user,

a data audit trail function and an instrument audit trail function. This ensures the reliability of data.

Security

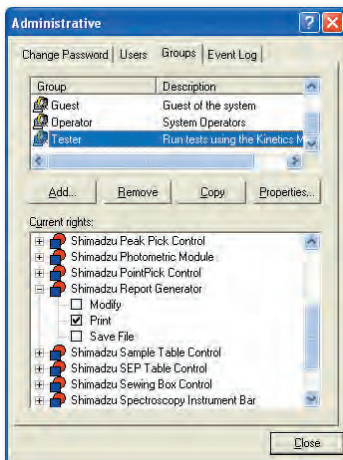

UVProbe enables software operations to be limited for the individual user. User management can be done for user groups as well.

Audit Trail

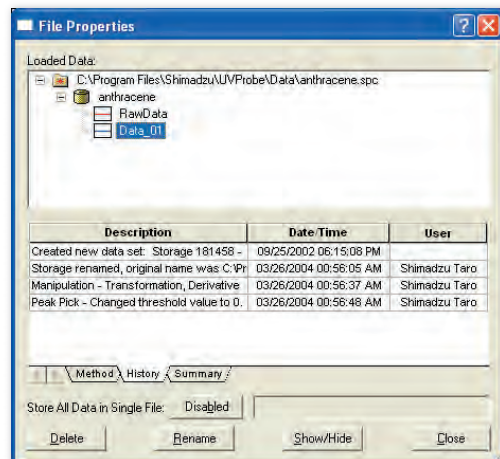

For example, when data processing is performed, the resultant data is stored together in the same file with the original data, which remains intact. The audit trail function tracks the instrument's history.

UVProbe

All-in-one Software

UVProbe includes four functions:

- Spectrum
- Photometric (Quantitation)
- Kinetics
- Report Generator

Each function can be easily operated with its dedicated screen. Included as standard are a wide variety of data processing functions such as peak/valley detection, area calculation, and others. Security features by which each user is limited to the use of specific functions, and an audit trail for the instrument and the data are all standard as well.

Spectrum

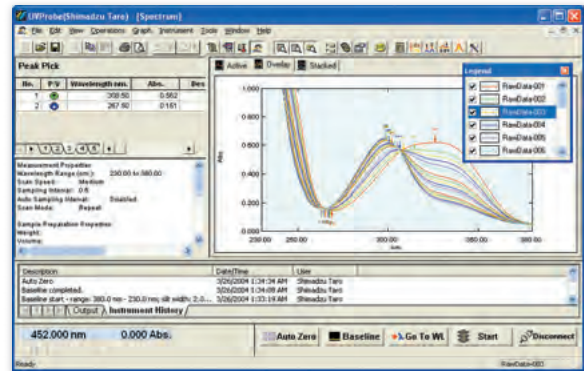

Kinetics

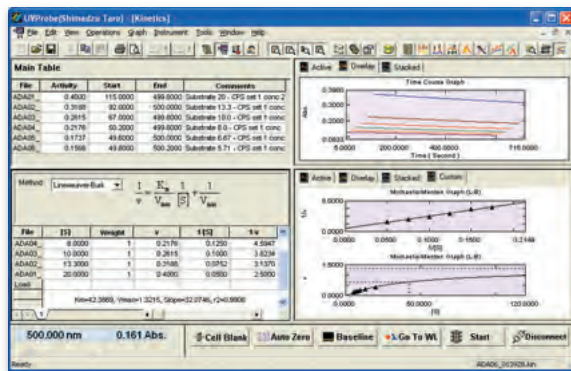

Photometric

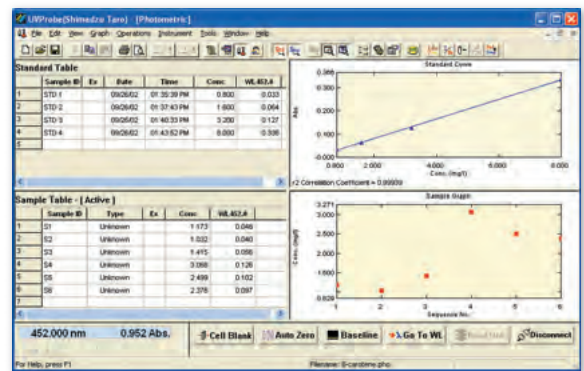

Report Generator

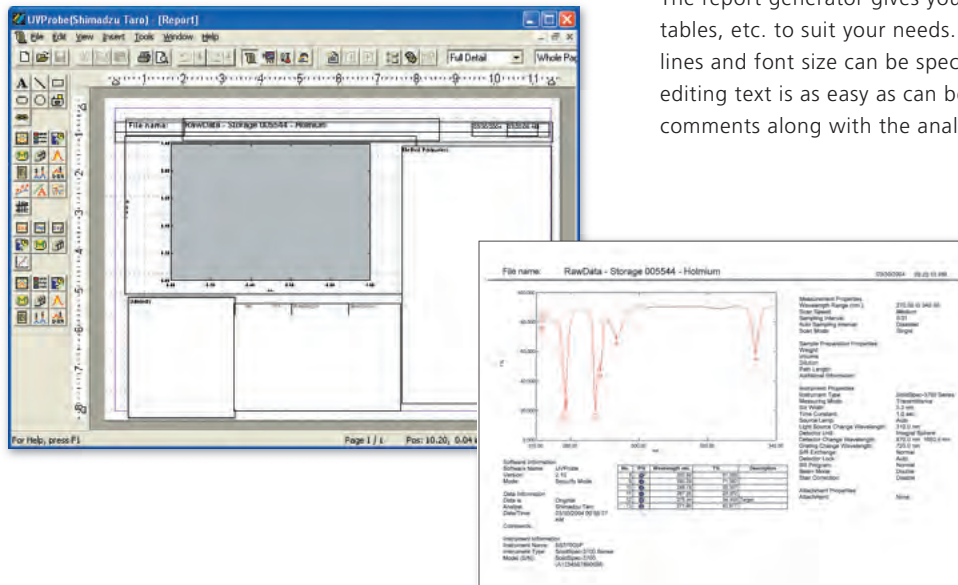

The report generator gives you the freedom to arrange graphs, tables, etc. to suit your needs. The thickness and color of graph lines and font size can be specified. Pasting labels on graphs and editing text is as easy as can be, allowing you to effectively print comments along with the analysis results.

Quick Print

Quick Print allows you to print data directly from the Spectrum, the Kinetics and the Photometric modules without moving to the Report Generator. Once the report template is stored as the

report file, the report can be printed simply by utilizing the 4th step, without steps 1 to 3.

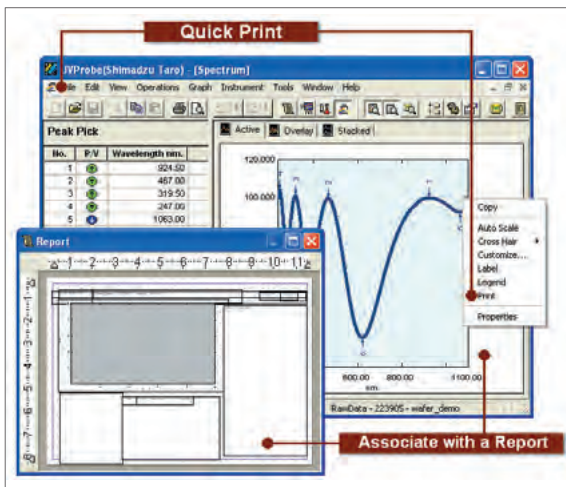

- Step 1** – Make the report template
- Step 2** – Assign the data to the report template
- Step 3** – Check the report to be printed
- Step 4** – Print the report by Quick Print

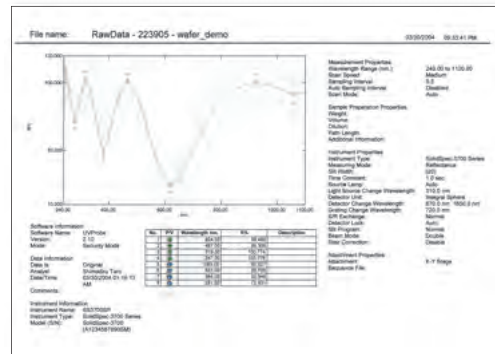

Reliability and Management of Data

As represented by ISO9001, the reliability and management of data have been increasingly required. UVProbe has security functions in which operations are limited for the individual user,

a data audit trail function and an instrument audit trail function. This ensures the reliability of data.

Security

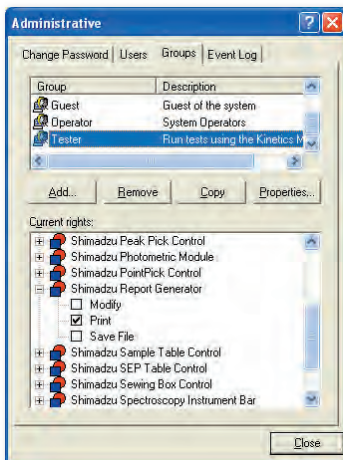

UVProbe enables software operations to be limited for the individual user. User management can be done for user groups as well.

Audit Trail

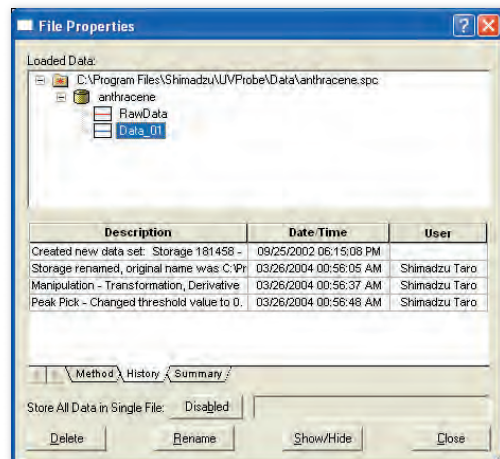

For example, when data processing is performed, the resultant data is stored together in the same file with the original data, which remains intact. The audit trail function tracks the instrument's history.

UVProbe

Pass or Fail Judgment Functions

Equations to judge pass/fail for measurement results within the Measurement Method in the Photometric Module can be created. Once the equation for the measurement values or the

calculation results is created, the judgments are shown in the sample table. Complicated equations with multiple wavelengths are also available.

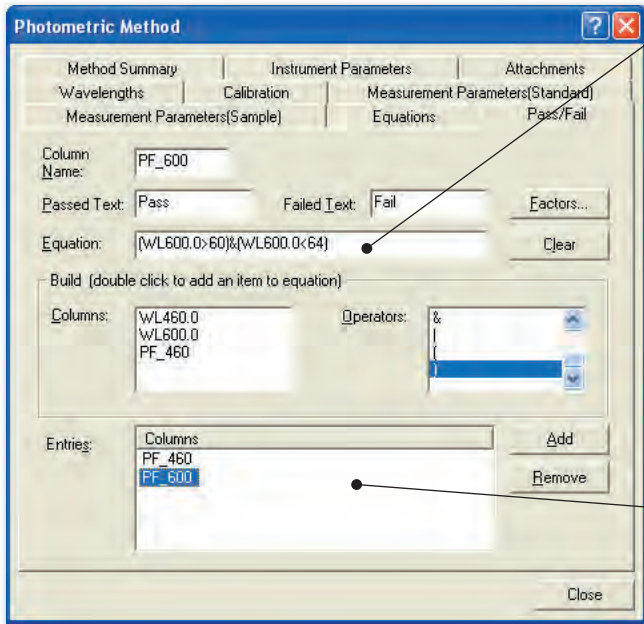

Creation of Equation

Equations for measurement result values or calculation results can be created. For example, this equation expresses that if the transmittance at 600nm (WL600.0) is higher than 60% and less than 64%, the Pass criteria is met. If not, a result of Fail is given.

Operators

The operators which can be used in the equation are given here.

Stored Equations

The stored equations are shown here. Multiple formulas can be stored.



Measurement

Sample Table - [Active]

	Sample ID	Type	Ex	WL460.0	WL600.0	PF_460	PF_600	Result	Comments
1	Filter_1	Unknown		57.669	62.621	Pass	Pass	Pass	
2	Filter_2	Unknown		56.184	61.475	Fail	Pass	Fail	
3	Filter_3	Unknown		59.351	64.758	Pass	Fail	Fail	
4	Filter_4	Unknown		60.579	65.907	Fail	Fail	Fail	
5	Filter_5	Unknown		57.100	62.468	Pass	Pass	Pass	
6	Filter_6	Unknown		58.841	63.947	Pass			
7	Filter_7	Unknown		57.901	63.139	Pass			
8	Filter_8	Unknown		56.076	61.423	Fail			
9									

Performs logical operation to determine if a sample is within a specified range or above or below a specified value.
Equation: (WL600.0>60)&(WL600.0<64)

The judgments given by the formula are shown with the measurement values.

A brief explanation for the column can be shown.

Open/Save for Measurement methods

UVProbe can open and save all of the created measurement methods as individual files. Once the measurement method, which also includes the equation, is saved, measurements under the same conditions can be repeated at any time.

Optional Software

Color Measurement Software P/N 206-65207

This software calculates color indices from the spectra given by the spectrophotometer.

- Presents indices of XYZ, Lab(Hunter), L*a*b*, L*u*v*, Munsell, whiteness, yellowness, metamerism, and many others.
- Recalculates any results with different parameters and conditions.
- Chromaticity diagram and magnified color difference diagram may be graphically displayed.
- Permits computation using user-defined illuminants, besides the standard ones. The user-defined illuminants may be stored as files to be recalled at any time.
- Correction using the standard white plate ensures high accuracy in color computation. The set standard values may be stored as files to be recalled at any time.
- Calculates color differences using the arbitrarily selected standard samples.
- Available convenient functions include thickness correction, smoothing, averaging, and standard deviation calculation.
- Up to 100 data may be displayed together.

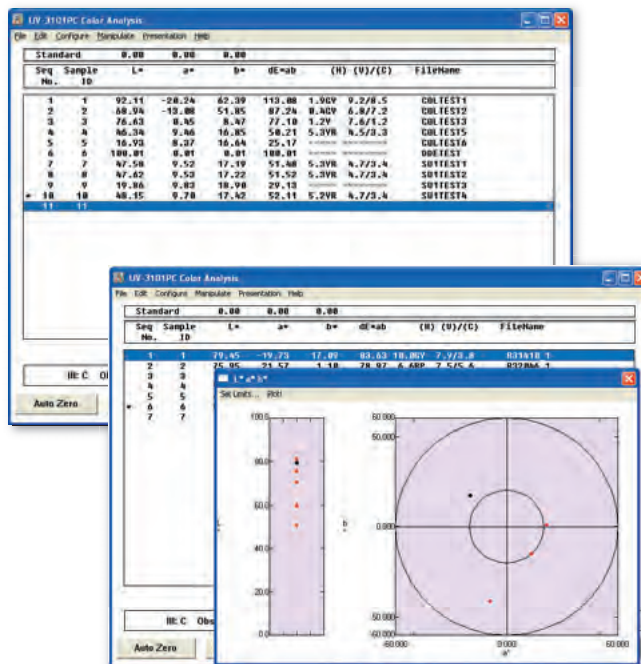

(Note) This software runs on Windows 7 Professional (32 bit) / XP Professional / Vista Business

Film Thickness Measurement Software P/N 206-65206

This software provides calculation of film thickness from the peak positions of the interference pattern.

Measurable thickness range is expressed by the next equation, though it somewhat differs with the type of samples

$$\frac{\lambda e}{n} < d < \frac{50\lambda s}{n}$$

λe : Shortest measured wavelength
 λs : Longest measured wavelength
 n : Refractive index of sample

Automatically detects valleys and peaks of interference spectrum.

Calculates film thickness from the wavelengths of all the peaks and valleys within the specified wavelength range. Wavelength range may be selected watching the interference pattern.

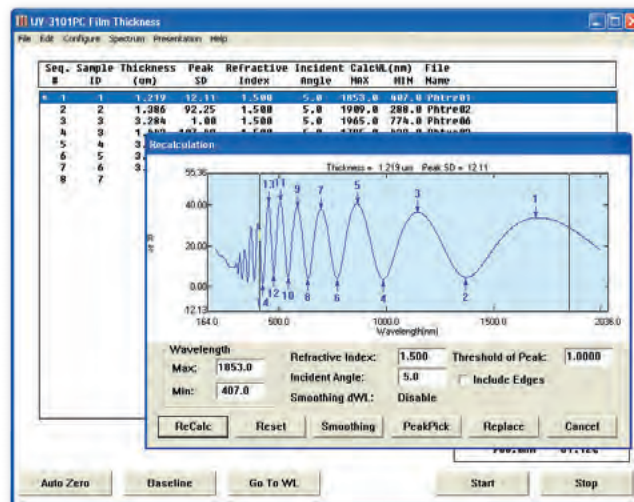

(Note) This software runs on Windows 7 Professional (32 bit) / XP Professional / Vista Business

Accessories

Automatic X-Y Stage P/N 206-20810-39

The Automatic X-Y Stage enables automatic measurements for the points specified in advance and is a powerful accessory for high-throughput measurements.

- Maximum sample size :
310 mm diameter or 310 × 310 mm, 40 mm thickness



Direct Detection Unit P/N 206-20264-91

DDU (For UV-3700) P/N 206-20264-91

DDU-DUV (For UV-3700) P/N 206-20264-92

The same sample compartment as a conventional UV-VIS spectrophotometer can be added to the SolidSpec-3700/3700DUV by mounting the Direct Detection Unit DDU or DDU-DUV.

- Measurement wavelength range :
DDU 190 to 3300 nm (when mounted in SolidSpec-3700)
DDU-DUV 165 to 3300 nm (when mounted in SolidSpec-3700DUV)



Purge Box P/N 206-21788-91

The Purge Box is used with the Direct Detection Unit DDU-DUV, allowing the inside to be purged. The Purge Box has a film holder and a six-cell holder and allows the cell positions to be moved without opening the cover of the SolidSpec-3700/3700DUV.

- Maximum sample size :
60 × 60 mm, 20 mm thickness

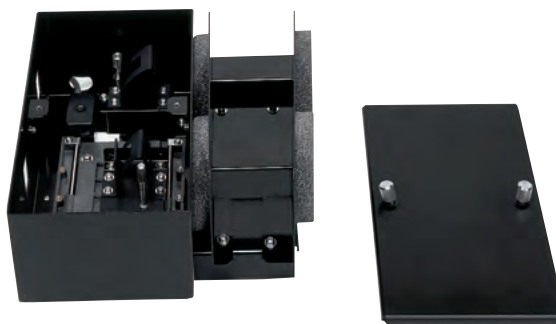

Absolute Specular Reflectance Attachment, 5 degrees

ASR-3105 P/N 206-16817

Absolute Specular Reflectance Attachment, 12 degrees

ASR-3112 P/N 206-16100

Absolute Specular Reflectance Attachment, 30 degrees

ASR-3130 P/N 206-15001

Absolute Specular Reflectance Attachment, 45 degrees

ASR-3145 P/N 206-15002

These attachments are used for the measurement of solid samples such as mirrors etc and require the BIS-3700 (P/N 206-20880-91) or BIS-3700DUV (P/N 206-20880-92). Since the polarization characteristics are more pronounced at higher angles of incidence (30 or 45 degrees), the optional Polarizer attachment is required to obtain accurate reflectance measurements.

Wavelength Range	
5 degrees	: 300 to 2400 nm
12 degrees	: 300 to 2500 nm
30 and 45 degrees	: 300 to 2300 nm

- V-N method : Optical path is easily switched between 100% measurement setting and sample measurement.
- Approximate sample size : 25 to 200(100)^(note) mm dia, or 20 to 150 (100) mm square, up to 30 mm thick.

Note) The maximum sample size for SolidSpec-3700DUV is shown in the parenthesis.

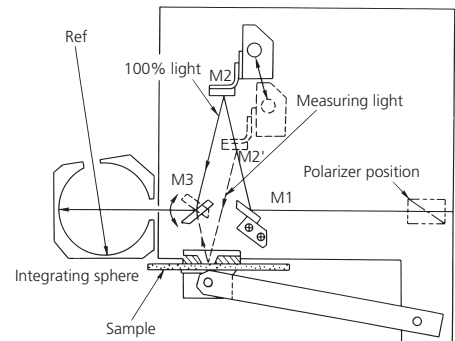

Structure of Absolute Specular Reflectance Attachment

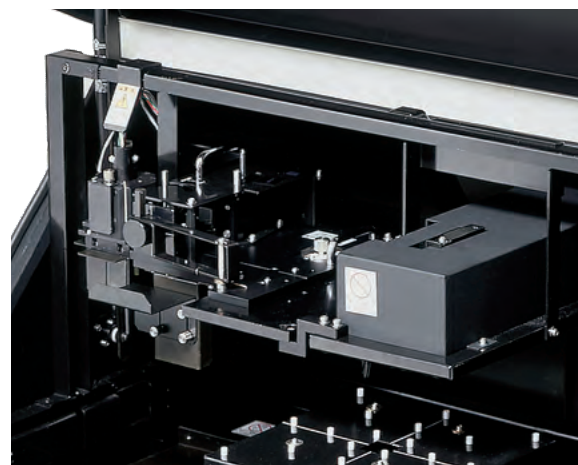

ASR-3112 mounted on BIS-3700

Sample Base Plate Integrating Sphere Set BIS-3700 (For UV-3700)

P/N 206-20880-91

Sample Base Plate Integrating Sphere Set BIS-3700DUV (For UV-3700DUV)

P/N 206-20880-92

BIS-3700/3700DUV are the integrating spheres with base plates. These are needed to install an Absolute Specular Reflectance Attachment in the SolidSpec-3700/3700DUV.



Measurement wavelength range	
BIS-3700	: 240 to 2600 nm (When mounted in Solidspec-3700)
BIS-3700DUV	: 175 to 2600 nm (When mounted in Solidspec-3700DUV)

Accessories

Large Specular Reflectance Attachment (5 degrees incident angle) P/N 206-20570-91

The Large Specular Reflectance Attachment is needed for the relative specular reflectance measurements. This accessory is mounted in the main body of the SolidSpec-3700/3700DUV and enables reflectance measurements even when keeping the samples horizontal. The Direct Detection Unit DDU or DDU-DUV is not required for this accessory.



- Applicable sample size: maximum 470W × 560D × 40H (mm)

Specular Reflectance Attachment (5 degrees incident angle) P/N 206-14046

The Specular Reflectance Attachment is used with the Direct Detection Unit (DDU or DDU-DUV). This accessory enables relative specular reflectance measurements without using an integrating sphere. The Direct Detection Unit DDU (P/N 206-20264-91) or DDU-DUV (P/N 206-20264-92) is required.



- Applicable sample size: maximum 260W × 120D × 250H (mm), 8kg

Large Polarizer Set, Polarizer Type 1, Type 2, Type 3, Polarizer Adaptor Set P/N 206-28212-91

Polarizers are needed to obtain highly precise absolute reflectance at large incident angles without affecting the polarization characteristics. The Polarizer Adaptor set (P/N 206-15693) is required for the Polarizer Type 1, Type 2 and Type 3.

	P/N	Effective Diameter	Wavelength Range
Large Polarizer Set	206-15694	20 mm	250 to 2500 nm
Polarizer Type I	206-13236-01	18 mm	400 to 800 nm
Polarizer Type II	206-13236-02	17 mm	260 to 700 nm
Polarizer Type III	206-13163	11 mm	260 to 2500 nm



Film Holder P/N 204-58909

The Film Holder is used to measure thin samples such as films and requires the Direct Detection Unit DDU (P/N 206-20264-91) or DDU-DUV (P/N 206-20264-92).

- Applicable sample size: minimum 16W × 32H (mm)
maximum 80W × 40H × 20t (mm)



10 mm Square Cell Holder for Integrating Sphere P/N 206-22339-92

The 10 mm Square Cell Holder for liquid sample measurement is mounted on the standard integrating sphere built into the SolidSpec-3700/3700DUV.



Specifications

Hardware

Wavelength range	· Solidspec-3700 Standard model 240 nm to 2600 nm, 190 nm to 3300 nm (when using Direct Detection Unit DDU) · Solidspec-3700DUV Deep UV model 175 nm to 2600 nm, 165 nm to 3300 nm (when using Direct Detection Unit DDU-DUV)
Spectral bandwidth	8 steps in ultraviolet and visible region : 0.1, 0.2, 0.5, 1, 2, 3, 5, 8 nm 10 steps in near-infrared region : 0.2, 0.5, 1, 2, 3, 5, 8, 12, 20, 32 nm
Resolution ^(note1)	0.1 nm
Display of wavelength	0.01 nm display
Wavelength accuracy ^(note1)	±0.2 nm in ultraviolet and visible region ±0.8 nm in near-infrared region
Wavelength repeatability ^(note1)	within ±0.08 nm in ultraviolet and visible region within ±0.32 nm in near-infrared region
Wavelength scanning speed	· Wavelength setting by About 18,000 nm/min in ultraviolet and visible region About 70,000 nm/min in near-infrared region · Wavelength scanning by Maximum 4,500 nm/min for ultraviolet and visible region, Maximum about 9,000 nm/min for near-infrared PMT and InGaAs, Maximum about 4,000 nm/min for near-infrared PbS
Switching of the light sources	The light sources are switched automatically in conjunction with wavelength scanning. The wavelength at which the light source is switched in the range of 282 nm to 393 nm in 0.1nm increments.
Stray light ^(note1)	Less than 0.00008% (220 nm, NaI) Less than 0.00005% (340 nm, NaNO ₂) Less than 0.0005% (1420 nm, H ₂ O) Less than 0.005% (2365 nm, CHCl ₃)
Photometric system	Double beam, direct ratio measuring system
Photometric range	-6 to 6 Abs
Photometric accuracy	±0.003 Abs(1 Abs), ±0.002 Abs(0.5Abs) determined with NIST 930D standard filter
Photometric repeatability	0.001 Abs (0 to 0.5 Abs), 0.002 Abs (0.5 to 1 Abs) determined under conditions of 1 second accumulation and maximum deviation for five times measurements
Noise	Under 0.0002 Abs (500 nm, SBW 8 nm), Under 0.00005 Abs (1500 nm, SBW 8 nm) determined under conditions of RMS value at 0 Abs and 1 second response When using the Direct Detection Unit DDU/DDU-DUV, under 0.00005 Abs (500 nm, SBW 2 nm), under 0.00008 Abs (900 nm, SBW 2 nm), under 0.00003 Abs (1500 nm, SBW 2 nm) determined under conditions of RMS value at 0 Abs and 1 second response.
Baseline flatness	±0.003 Abs (240 to 350 nm, SBW 8 nm) ±0.002 Abs (350 to 1600 nm, Visible region : SBW 8 nm, Near-infrared region : SBW 20 nm) ±0.004 Abs (1600 to 2600 nm, SBW 20 nm)
Drift	SolidSpec-3700DUV : Within 0.0002 Abs/h (after 2 hours warm-up, 500 nm, 1 second accumulation) SolidSpec-3700DUV : Within 0.0003 Abs/h (after 2 hours warm-up, 500 nm, 1 second accumulation)
Light source	50 W halogen lamp (2000 hours life), Deuterium lamp (socket type, 1250 hours life for SolidSpec-3700, 300 hours life for SolidSpec-3700DUV) The automatic position alignment is used for maximum sensitivity
Monochromator	Grating - grating type monochromator Pre-monochromator : Concave diffraction monochromator (2 switchable diffraction gratings) Main monochromator : Czerny-Turner mounting (2 switchable diffraction gratings) High-performance blazed holographic grating in aberration-corrected
Detector	Ultraviolet and visible region : R-928 (SolidSpec-3700), R-955 (SolidSpec-3700DUV) Near-infrared region : InGaAs and cooled PbS cell for both
Sample compartment	Inside dimensions : 900W × 700D × 350H (mm) Maximum sample size : 700W × 560D × 40H (mm)
Dimensions / Weight	1000W × 800D × 1200H (mm) (Not including the protruding portions), 170Kg
Ambient temperature	15 to 35 degrees centigrade
Ambient humidity	35 to 80% (at room temperature 15 to 30 degrees centigrade), 35 to 70% (at room temperature 30 to 35 degrees centigrade) No condensation
Power requirement	AC 100 V/120 V/220 V/230 V/240 V, 50/60 Hz 300 VA ^(note2)

The specifications shown above are determined after 2 hours warm-up.

Note1) Determined using the Direct Detection Unit DDU.

Note2) PC and printer are not included.

Note: When the deep UV region is measured on the SolidSpec-3700DUV, nitrogen gas purge is needed to remove the inside oxygen gas. The flow rate of nitrogen gas is 80 L/min to 100 L/min (50 L/min when using the Direct Detection Unit DDU-DUV). Since a large amount of high-purity nitrogen gas is required, supplying liquid nitrogen is recommended. The recommended specifications of nitrogen gas are purity over 99.999% and supply pressure of around 0.2 MPa. It takes approximately one hour (30 minutes when using the Direct Detection Unit) to purge the inside of the SolidSpec-3700DUV before measuring samples. The installation site of the SolidSpec-3700DUV must be ventilated to keep the oxygen concentration over 18%. It is recommended that the SolidSpec-3700DUV be installed in a room which has an exhaust system such as a draft chamber (around 20 m³/min) or ventilation hood.

Software

Data Acquisition Modes	Spectrum, Kinetics and Photometric
General	Multitasking (Possible to execute data processing while measurement is being executed.) Customizable measurement screen layout (wavelengths, data display font and font size, colors, displayed number of rows) GLP/GMP compliant (security, history), Real time concentration display
Spectrum Mode	Comparison of multiple spectra/relative processing ^(note) Save all processed data with original data set including a history of all manipulations Spectrum enlargement/shrinking, auto scale and Undo/Redo of these operations. Annotation on spectrum screen.
Data Processing in Spectrum Mode	Normalization, Point pick, Peak/Valley detection, Area calculation, Transformation: 1 st -4 th derivatives, Smoothing, Reciprocal, Square root, Natural log, Logarithm power, Abs to %T conversion, Exponential conversion, Kubelka-Munk conversion, Ensemble averaging, Interpolation, data set and constants arithmetic (between spectra, between spectra and constants)
Photometric (Quantitation) Mode	Single wavelength, Multi wavelength (includes 1, 2 or 3 wavelengths), Spectrum quantitation (peak, maximum minimum, area, etc. for specified wavelength ranges) Multi-point, Single point, K-factor calibration curves (1 st , 2 nd , 3 rd order function fits, pass-through-zero specification) Photometric processing with user-defined functions (+, -, x, /, Log, Exp, etc. functions, including factors) Weight correction, Dilution factor correction and other corrections using factors Averaging of repeat measurement data, Simultaneous display of standard table, unknown table and calibration curves, Display of Pass/Fail indications
Kinetics (Time Course) Mode	Comparison/relative data processing of multiple time course data ^(note) Single or double wavelength measurement (difference or ratio) Unitary management of sample information including original data, sample weight and dilution factors, etc. Time course spectrum data processing (same as in data processing)
Report Generator	Preview and print function for customized formats, Layout and editing of templates, Quick printing using report template Multi-page printout support. Insert data, time, text and drawing objects including lines, circles and rectangles Insert spectrum and quantitation data, method and history Headers and footers easily inserted, Specify graph line thickness (as in all modules), font style and size

Note) Depends on PC environment (memory, etc.), As a guideline, from 20-30 spectrum data sets.
A PC (and a power supply for the PC) is required separately.

PC Requirements

Operating System	Windows XP Professional	Windows 7 Professional (32 bit) Vista Business
CPU	Pentium II 400 MHz and later	Intel 32 bit 1 GHz and later
RAM	256 MB and more	1 GB and More

- 1 GB and more for HDD free space
- Mouse or similar pointing device
- Graphic printer
- Serial port
- XGA video monitor and adapter (1024 × 768 dot screen resolution is recommended)
- CD-ROM drive

Even with the above configuration, UVProbe operating performance cannot be guaranteed, depending on Windows settings, hardware state, etc.
Use Shimadzu recommended equipment, if possible.

Dimensions

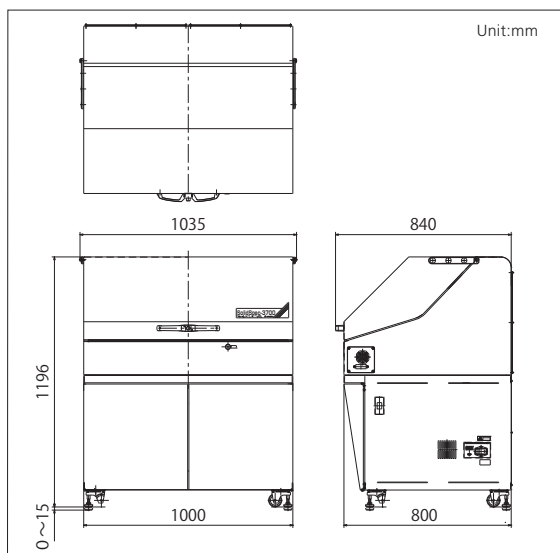

Inside dimensions

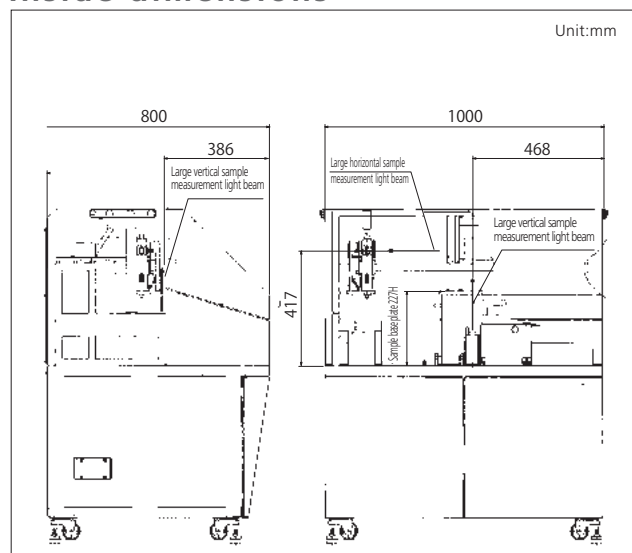



Shimadzu Corporation
www.shimadzu.com/an/

Company names, product/service names and logos used in this publication are trademarks and trade names of Shimadzu Corporation or its affiliates, whether or not they are used with trademark symbol "TM" or "®".
Third-party trademarks and trade names may be used in this publication to refer to either the entities or their products/services. Shimadzu disclaims any proprietary interest in trademarks and trade names other than its own.

For Research Use Only. Not for use in diagnostic procedures.
The contents of this publication are provided to you "as is" without warranty of any kind, and are subject to change without notice. Shimadzu does not assume any responsibility or liability for any damage, whether direct or indirect, relating to the use of this publication.